



2023



PERGOLA TENDE



INDEX

01

OSNOVE TENDI

03

SOMFY

04

TABELA MOTORA

05

FRIENDLY PRICE 10 (FP-10)

09

FRIENDLY PRICE 20 (FP-20)

13

FRIENDLY PRICE 30 (FP-30)

17

FRIENDLY PRICE 40 (FP-40)

21

FRIENDLY PRICE 50 (FP-50)

25

FRIENDLY PRICE 60 (FP-60)

29

PREMIUM PRICE 10 (PP-10)

33

PREMIUM PRICE 20 (PP-20)

37

PREMIUM PRICE 30 (PP-30)

41

PREMIUM PRICE 40 (PP-40)

45

PREMIUM PRICE 50 (PP-50)

49

PREMIUM PRICE 60 (PP-60)

53

NOVI SISTEMI

55

REFERENTNI PROJEKTI

57

KLIZNI I VERTIKALNI SISTEM
ZASTAKLJENJA

61

SCREEN - ZAŠTITA OD SUNCA

67

WPC DECKING

71

REFERENTNI PROJEKTI

The logo for RATTAN SEDIA features a stylized icon on the left composed of several rectangular blocks in shades of brown and gold. To the right of the icon, the word "RATTAN" is written in a large, bold, sans-serif font, and "S E D I A" is written below it in a smaller, spaced-out, sans-serif font. Both are in a gold color.

www.rattansedia.com

OSNOVE TENDE

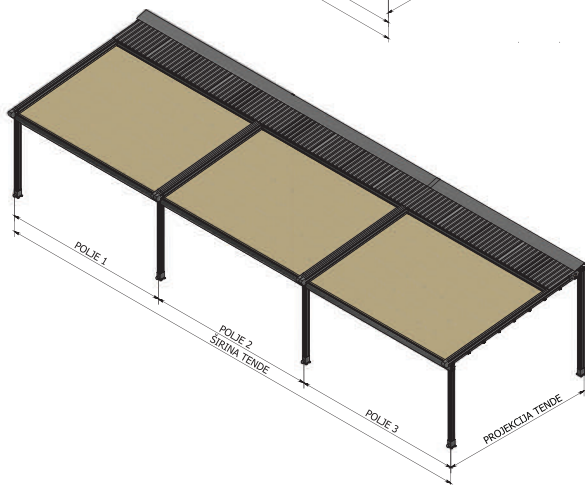
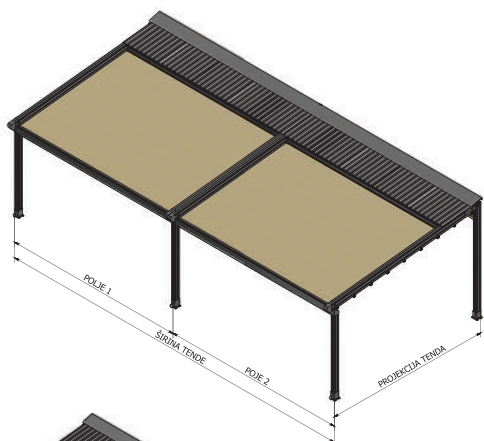
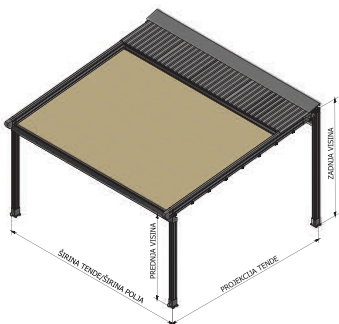

1

ŠIRINA TENDE

Predstavlja razmak između vanjskih strana i krajnjih prednjih stubova tende.

Prostor koji je potreban za montažu tende treba da bude minimalno 10cm širi u odnosu na širinu tende jer pojedini dijelovi tende izlaze van gabarita tende.

To se posebno odnosi na stope prednjih, bočnih i zadnjih stubova te na nosač motora tende.

DUŽINA TENDE

Predstavlja razmak od objekta na koji se montira tenda ili vanjske strane zadnjeg stuba tende pa sve do vanjske strane prednjeg stuba tende.

Prostor koji je potreban za montažu tende treba da bude minimalno 15 do 20cm duži u odnosu na dužinu tende jer pojedini dijelovi tende izlaze van gabarita tende.

To se posebno odnosi na kape tende, nosače zadnje grede kao na odliv vode iz tende.

2

VISINA TENDE

Prednja visina tende predstavlja razmak između podloge na koju se tenda montira i donje površine oluka tende.

Prednja visina tende predstavlja razmak između podloge na koju se tenda montira i gornje površine zadnje grede.

3

Visina koja je potrebna za montažu tende treba da bude minimalno 70cm veća u odnosu na prednju i zadnju visinu tende jer pojedini dijelovi tende izlaze van gabarita tende te je potrebno obezbijediti dovoljno prostora monterima za adekvatnu montažu tende.

OGRANIČENJE: MAX PROJEKCIJA TENDE

SISTEM	FP	PP	NS
MAX PROJEKCIJA TENDE	7m	10m	6m

MAX ŠIRINA TENDE SA JEDNIM PLATNO U ZAVISNOSTI OD BROJA POLJA

BROJ POLJA	I	II	III
MAX ŠIRINA TENDE	4,5m	9m	13,5m

NAPOMENA:

Maksimalna ograničenja na širinu tende predstavljena u tabeli se odnose samo ukoliko je tenda izvedena iz jednog platna koje nije šire od 13,5m. Ukoliko projekat zahtjeva da tenda bude šira od 13,5m onda se tenda izvodi sa dva ili više platna.

SOMFY

Za efikasno otvaranje i zatvaranje krova tende koristi-
mo „IO MOTORE“ sa ugrađenim prijemnikom i „RTS
MOTORE“ renomiranog francuskog proizvođača
SOMFY koje karakteriše veoma tih rad, brzina u otva-
ranju i zatvaranju krova tende te dugotrajnost i izdržl-
jivost u radu.



TABELA MOTORA:

Pergola tende Rattan Sedia se pokreću Somfy motorima kako slijedi:

IO 85 Nm/17	IO 120 Nm/12	RTS 80 Nm/12	RTS 100 Nm/12	RTS 120 Nm/12
IO 50 Nm/12		RTS 50 Nm/12		

NAPOMENA:

„IO“ motore koristimo ukoliko je projektom predviđeno da ide jedan motor za jedno platno, a „RTS“ motore koristimo ukoliko je projektom predviđeno da idu dva motora za jedno platno.

TABELA MOTORA

ŠIRINA TENDE

		1m	2,5m	4,5m	6m	7,5m	10m	13,5m
P R O J E K T I J A T E N D E	1m	IO 85Nm/17	IO 85Nm/17	IO 85Nm/17	IO 85Nm/17	IO 85Nm/17	IO 85Nm/17	IO 85Nm/17
	2m	IO 85Nm/17	IO 85Nm/17	IO 85Nm/17	IO 85Nm/17	IO 85Nm/17	IO 85Nm/17	IO 85Nm/17
	3m		IO 85Nm/17	IO 85Nm/17	IO 85Nm/17	IO 85Nm/17	IO 85Nm/17	IO 120Nm/12
	4m	IO 85Nm/17	IO 85Nm/17	IO 85Nm/17	IO 85Nm/17	IO 85Nm/17	IO 120Nm/12	IO 120Nm/12
	5m	IO 85Nm/17	IO 85Nm/17	IO 85Nm/17	IO 85Nm/17	IO 120Nm/12	IO 120Nm/12	RTS 80Nm/12
	6m	IO 85Nm/17	IO 85Nm/17	IO 85Nm/17	IO 120Nm/12	IO 120Nm/12	IO 120Nm/12	RTS 100Nm/12
	7m	IO 85Nm/17	IO 85Nm/17	IO 85Nm/17	IO 120Nm/12	IO 120Nm/12	RTS 80Nm/12	RTS 100Nm/12
	8m	IO 85Nm/17	IO 85Nm/17	IO 120Nm/12	IO 120Nm/12	RTS 80Nm/12	RTS 80Nm/12	RTS 120Nm/12
	9m	IO 85Nm/17	IO 85Nm/17	IO 120Nm/12	IO 120Nm/12	RTS 80Nm/12	RTS 100Nm/12	RTS 120Nm/12
	10m	IO 85Nm/17	IO 85Nm/17	IO 120Nm/12	IO 120Nm/12	RTS 80Nm/12	RTS 100Nm/12	RTS 120Nm/12

MOTORI ZA NS SISTEM

POVRŠINA

DO 25m²

PREKO 25m²

MOTOR

IO 50 Nm/12

RTS 50 Nm/12



FP-10

Pergola tenda

FP – 10

PERGOLA TENDA

Pergola tenda FRIENDLY PRICE – 10

Predstavlja jednovodni sistem pergola tende konstruisan od aluminijskih profila i troslojnog PVC platna. Glavna karakteristika ovog sistema je to da se tenda oslanja zadnjim dijelom na objekat ili neku drugu postojeću konstrukciju a prednjim dijelom preko prednjih stubova na podlogu.

Otvaranje i zatvaranje krova tende se vrši na motorni pogon i upravlja daljinskim upravljačem.

BOJA PROFILA:

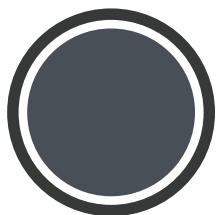

ANTRACIT

BOJA PLATNA:

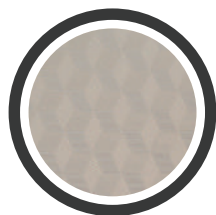

KREM 3D

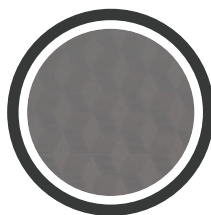

SIVA 3D



FP – 10

Model

Specifikacije

Maksimalna projekcija: 7m

Boja profila: Antracit (osnova)

Boja platna: 3D Siva ili krem

Somfy elektromotor

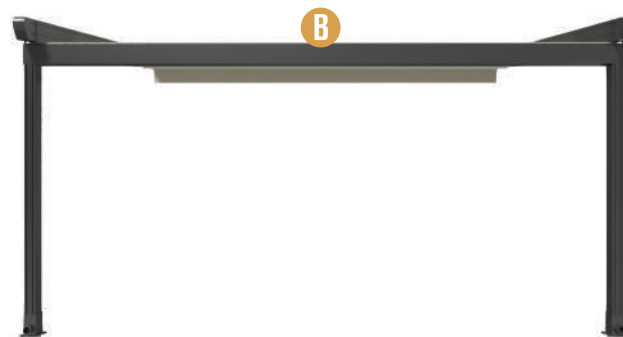

POPREČNI PRESJECI

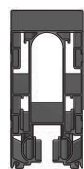

A

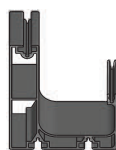

B



C



D

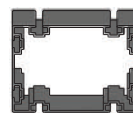

E

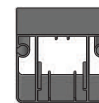

F

ALUMINIJSKI PROFILI

ZA NOVI SISTEM PERGOLA TENDE

A

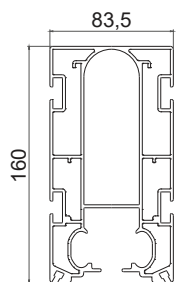

PROFIL VODILICE

DIMENZIJA: 160x83,5mm

Aluminijum LEGURE EN AW-6063, čvrstoća F22

B

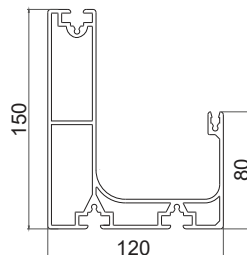

PROFIL OLUKA

DIMENZIJA: 150x120mm

Aluminijum LEGURE EN AW-6063, čvrstoća F22

C

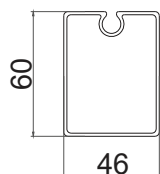

PROFIL MALE PERGOLE

DIMENZIJA: 60x46mm

Aluminijum LEGURE EN AW-6063, čvrstoća F22

D

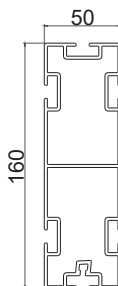

PROFIL ZIDNI - FASADNI

DIMENZIJA: 160x50mm

Aluminijum LEGURE EN AW-6063, čvrstoća F22

E

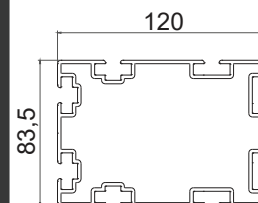

PROFIL STUBA - GREDA

DIMENZIJA: 120x88,5mm

Aluminijum LEGURE EN AW-6063, čvrstoća F22

F

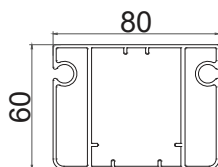

PROFIL VELIKE PERGOLE

DIMENZIJA: 80x60mm

Aluminijum LEGURE EN AW-6063, čvrstoća F22

1

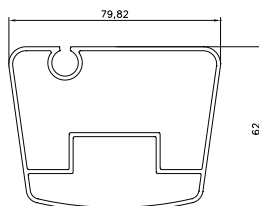

PROFIL VELIKE PERGOLE

DIMENZIJA: 79,82x62mm

Aluminijum LEGURE EN AW-6063, čvrstoća F22

2

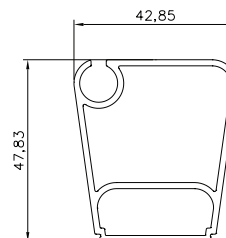

PROFIL MALE PERGOLE

DIMENZIJA: 42,85x47,83mm

Aluminijum LEGURE EN AW-6063, čvrstoća F22



RATTAN
S E D I A

FP-20

Pergola tenda

FP – 20

PERGOLA TENDA

Pergola tenda FRIENDLY PRICE – 20

Predstavlja jednovodni sistem pergola tende konstruisan od aluminijskih profila i troslojnog PVC platna. Glavna karakteristika ovog sistema je to da se tenda preko svojih zadnjih, bočnih i prednjih stubova oslanja na podlogu. Dodatno ojačanje ove tende predstavljaju bočne grede koje povezuju stubove i time ojačavaju konstrukciju tende. Nije potrebno da se tenda veže za bilo koju dodatnu konstrukciju ili objekat i kao takva funkcioniše kao samostalna samostojeća tenda.

Otvaranje i zatvaranje krova tende se vrši na motorni pogon i upravlja daljinskim upravljačem.

BOJA PROFILA:

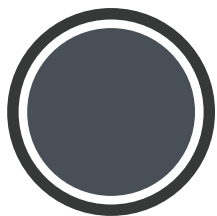

ANTRACIT

BOJA PLATNA:

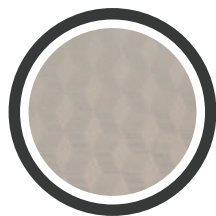

KREM 3D

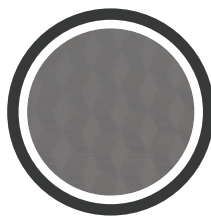

SIVA 3D



FP - 20

Model

Specifikacije

Maksimalna projekcija: 7m

Boja profila: Antracit (osnova)

Boja platna: 3D Siva ili krem

Somfy elektromotor

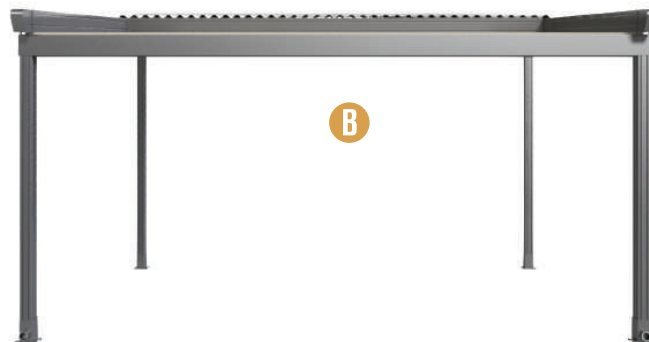

POPREČNI PRESJECI



A

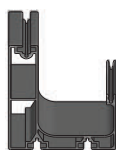

B



C

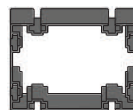

D

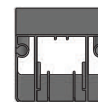

E

ALUMINIJSKI PROFILI

ZA NOVI SISTEM PERGOLA TENDE

A

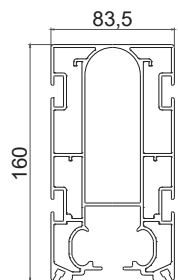

PROFIL VODILICE

DIMENZIJA: 160x83,5mm

Aluminijum LEGURE EN AW-6063, čvrstoće F22

B

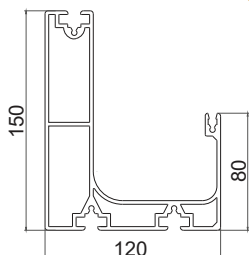

PROFIL OLUKA

DIMENZIJA: 150x120mm

Aluminijum LEGURE EN AW-6063, čvrstoće F22

C

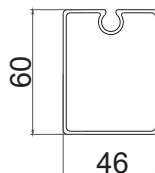

PROFIL MALE PERGOLE

DIMENZIJA: 60x46mm

Aluminijum LEGURE EN AW-6063, čvrstoće F22

D

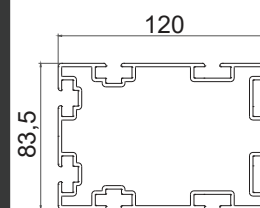

PROFIL STUBA-GREDA

DIMENZIJA: 120x83,5mm

Aluminijum LEGURE EN AW-6063, čvrstoće F22

E

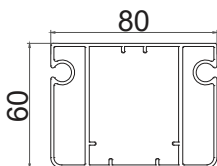

PROFIL VELIKE PERGOLE

DIMENZIJA: 80x60mm

Aluminijum LEGURE EN AW-6063, čvrstoće F22

1

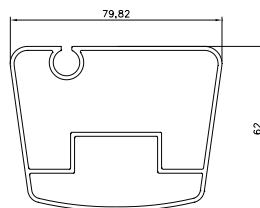

PROFIL VELIKE PERGOLE

DIMENZIJA: 79,82x62mm

Aluminijum LEGURE EN AW-6063, čvrstoće F22

2

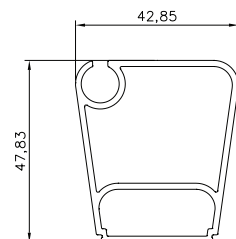

PROFIL MALE PERGOLE

DIMENZIJA: 42,85x47,83mm

Aluminijum LEGURE EN AW-6063, čvrstoće F22



FP-30

Pergola tenda

FP – 30

PERGOLA TENDA

Pergola tenda FRIENDLY PRICE – 30

Predstavlja jednovodni sistem pergola tende konstruisan od aluminijumskih i čeličnih profila te troslojnog PVC platna. Glavna karakteristika ovog sistema je ta da ova tenda nema prednjih stubova već se stabilnost tende ostvaruje sa čeličnim zategama. Zadnji dio tende se oslaja na objekat ili čelične stubove koji imaju ulogu da prihvate zatege i time povežu prednji i zadnjih dio tende u stabilnu konstrukciju.

Otvaranje i zatvaranje krova tende se vrši na motorni pogon i upravlja daljinskim upravljačem.

BOJA PROFILA:

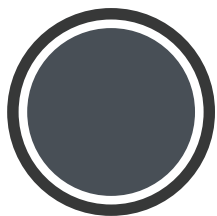

ANTRACIT

BOJA PLATNA:

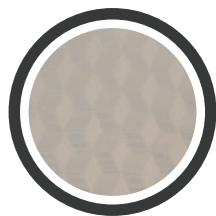

KREM 3D

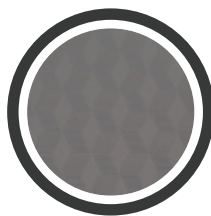

SIVA 3D



FP - 30

Model

Specifikacije

Maksimalna projekcija: 7m

Boja profila: Antracit (osnova)

Boja platna: 3D Siva ili krem
Somfy elektromotor

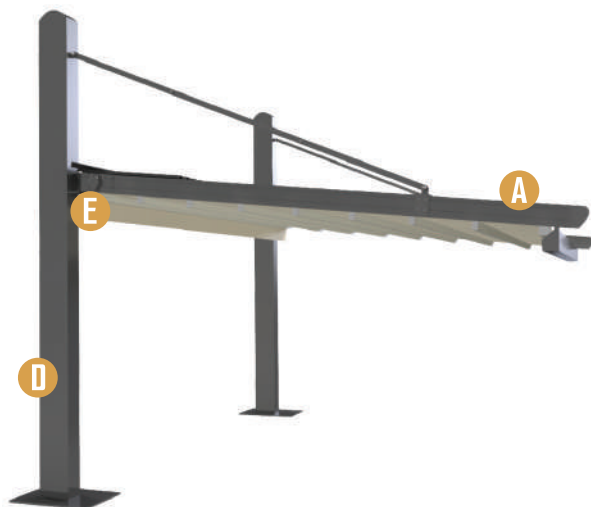

POPREČNI PRESJECI

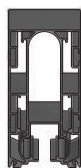

A

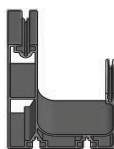

B



C

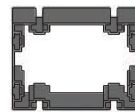

D

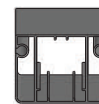

E

ALUMINIJSKI PROFILI

ZA NOVI SISTEM PERGOLA TENDE

A

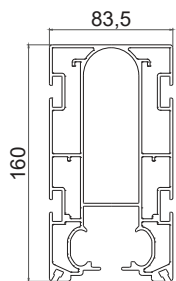

PROFIL VODILICE

DIMENZIJA: 160x83,5mm

Aluminijum LEGURE EN AW-6063, čvrstoće F22

B

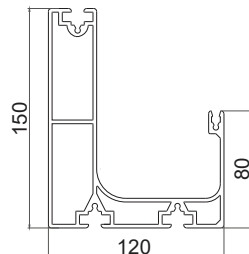

PROFIL OLUKA

DIMENZIJA: 150x120mm

Aluminijum LEGURE EN AW-6063, čvrstoće F22

C

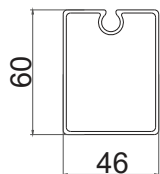

PROFIL MALE PERGOLE

DIMENZIJA: 60x46mm

Aluminijum LEGURE EN AW-6063, čvrstoće F22

D

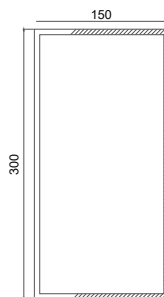

PROFIL ZIDNJEG STUBA

DIMENZIJA: 300x150mm

Aluminijum LEGURE EN AW-6063, čvrstoće F22

E

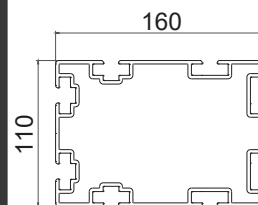

PROFIL STUBA-GREDA

DIMENZIJA: 160x110mm

Aluminijum LEGURE EN AW-6063, čvrstoće F22

F

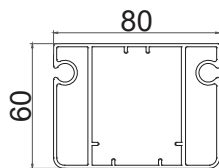

PROFIL VELIKE PERGOLE

DIMENZIJA: 80x60mm

Aluminijum LEGURE EN AW-6063, čvrstoće F22

1

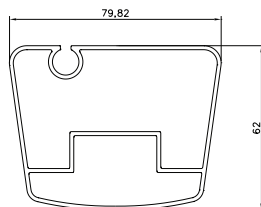

PROFIL VELIKE PERGOLE

DIMENZIJA: 79,82x62mm

Aluminijum LEGURE EN AW-6063, čvrstoće F22

2

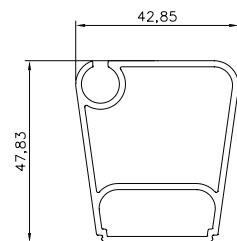

PROFIL MALE PERGOLE

DIMENZIJA: 42,85x47,83mm

Aluminijum LEGURE EN AW-6063, čvrstoće F22



FP-40

Pergola tenda

FP - 40

PERGOLA TENDA

Pergola tenda FRIENDLY PRICE - 40

Predstavlja jednovodni sistem pergola tende konstruisan od aluminijskih i čeličnih profila te troslojnog PVC platna. Glavna karakteristika ovog sistema je ta da ova tenda nema prednjih i zadnjih stubova već se preko srednjih stubova i zatega koje povezuju prednji i zadnji dio tende dobija stabilna konstrukcija. Poseban detalj koji izdvaja ovu tendu od ostalih modela je taj što je srednji stub dizajniran u obliku luka i estetski se izdvaja od ostalih modela kao i da svako polje ove tende ima platno koje se zasebno otvara i zatvara.

Otvaranje i zatvaranje krova tende se vrši na motorni pogon i upravlja daljinskim upravljačem.

BOJA PROFILA:

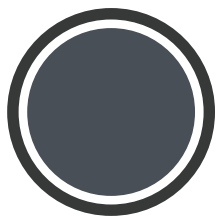

ANTRACIT

BOJA PLATNA:

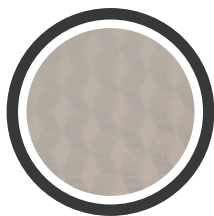

KREM 3D

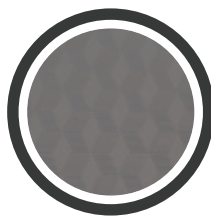

SIVA 3D



FP - 40

Model

Specifikacije

Maksimalna projekcija: 7m

Boja profila: Antracit (osnova)

Boja platna: 3D Siva ili krem

Somfy elektromotor

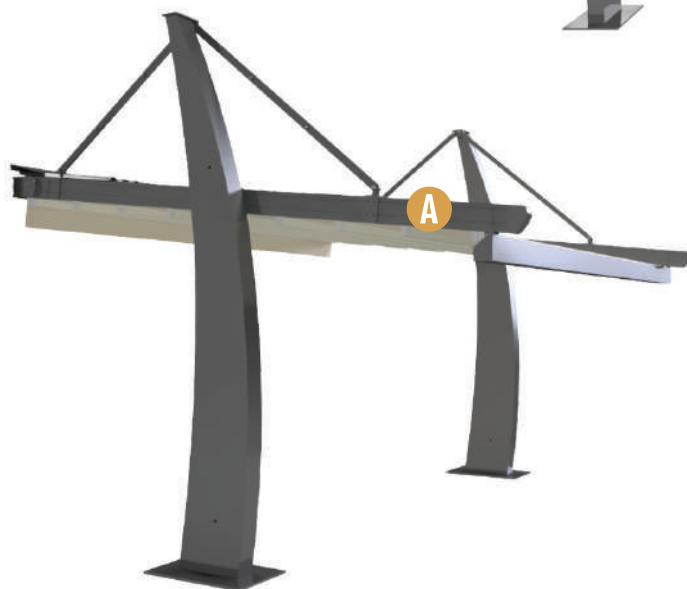
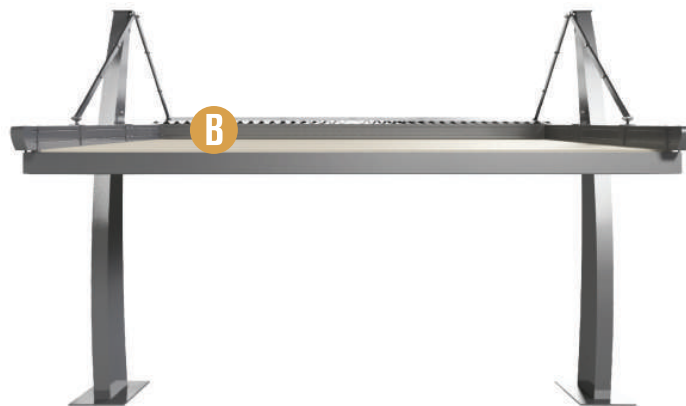

POPREČNI PRESJECI

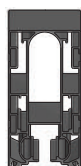

A

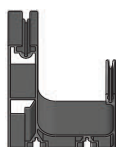

B



C



D

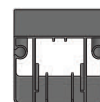

E

ALUMINIJSKI PROFILI

ZA NOVI SISTEM PERGOLA TENDE

A

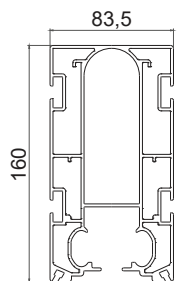

PROFIL VODILICE

DIMENZIJA: 160x83,5mm

Aluminijum LEGURE EN AW-6063, čvrstoće F22

B

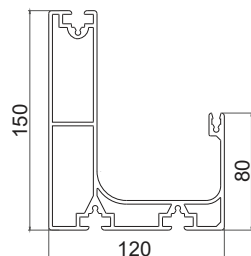

PROFIL OLUKA

DIMENZIJA: 150x120mm

Aluminijum LEGURE EN AW-6063, čvrstoće F22

C

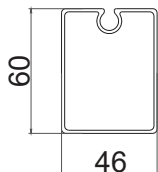

PROFIL MALE PERGOLE

DIMENZIJA: 60x46mm

Aluminijum LEGURE EN AW-6063, čvrstoće F22

D

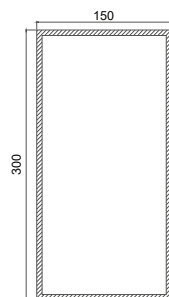

PROFIL ZIDNJEG STUBA

DIMENZIJA: 300x150mm

Aluminijum LEGURE EN AW-6063, čvrstoće F22

E

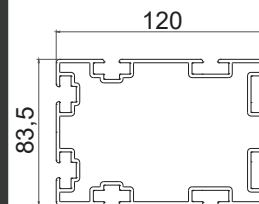

PROFIL STUBA-GREDA

DIMENZIJA: 120x83,5mm

Aluminijum LEGURE EN AW-6063, čvrstoće F22

F

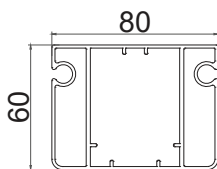

PROFIL VELIKE PERGOLE

DIMENZIJA: 80x60mm

Aluminijum LEGURE EN AW-6063, čvrstoće F22

1

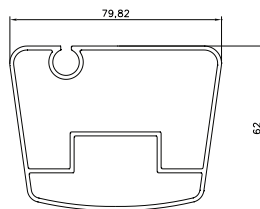

PROFIL VELIKE PERGOLE

DIMENZIJA: 79,82x62mm

Aluminijum LEGURE EN AW-6063, čvrstoće F22

2

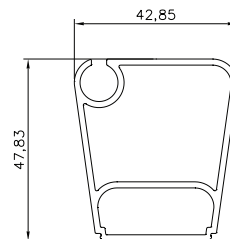

PROFIL MALE PERGOLE

DIMENZIJA: 42,85x47,83mm

Aluminijum LEGURE EN AW-6063, čvrstoće F22



FP-50

Pergola tenda

FP – 50

PERGOLA TENDA

Pergola tenda FRIENDLY PRICE – 50

Predstavlja dvovodni sistem pergola tende konstruisan od aluminijskih profila i troslojnog PVC platna. Glavna karakteristika ovog sistema je to da se tenda preko svojih srednjih, bočnih i prednjih stubova oslanja na podlogu. Dodatno ojačanje ove tende predstavljaju bočne grede koje povezuju stubove i time ojačavaju konstrukciju tende. Nije potrebno da se tenda veže za bilo koju dodatnu konstrukciju ili objekat i kao takva funkcioniše kao samostalna samostojeća tenda.

Otvaranje i zatvaranje krova tende se vrši na motorni pogon i upravlja daljinskim upravljačem.

BOJA PROFILA:

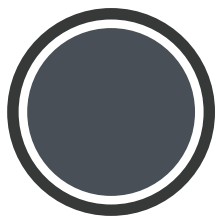

ANTRACIT

BOJA PLATNA:

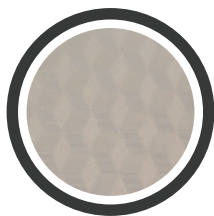

KREM 3D

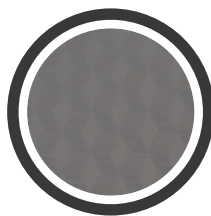

SIVA 3D



FP - 50

Model

Specifikacije

Maksimalna projekcija: 7m

Boja profila: Antracit (osnova)

Boja platna: 3D Siva ili krem

Somfy elektromotor

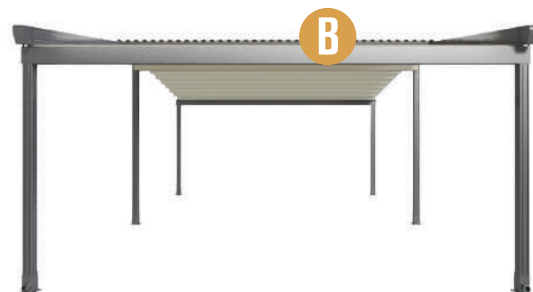

POPREČNI PRESJECI



A

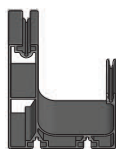

B



C

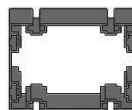

D

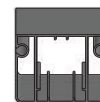

E

ALUMINIJSKI PROFILI

ZA NOVI SISTEM PERGOLA TENDE

A

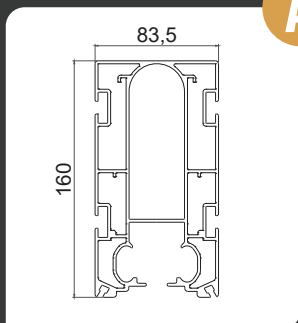

PROFIL VODILICE

DIMENZIJA: 160x83,5mm

Aluminijum LEGURE EN AW-6063, čvrstoće F22

B

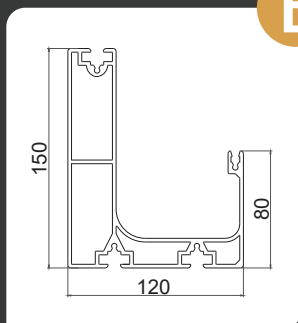

PROFIL OLUKA

DIMENZIJA: 150x120mm

Aluminijum LEGURE EN AW-6063, čvrstoće F22

C

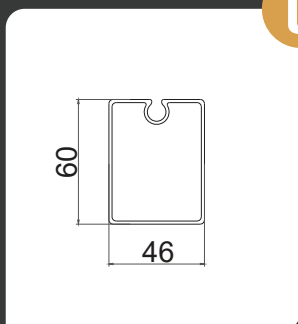

PROFIL MALE PERGOLE

DIMENZIJA: 60x46mm

Aluminijum LEGURE EN AW-6063, čvrstoće F22

D

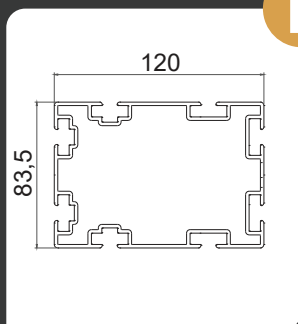

PROFIL STUBA-GREDA

DIMENZIJA: 120x83,5mm

Aluminijum LEGURE EN AW-6063, čvrstoće F22

E

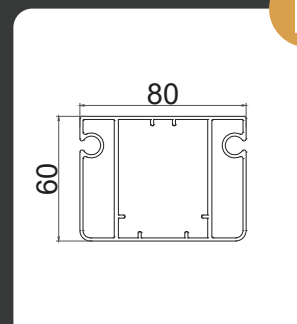

PROFIL VELIKE PERGOLE

DIMENZIJA: 80x60mm

Aluminijum LEGURE EN AW-6063, čvrstoće F22

1

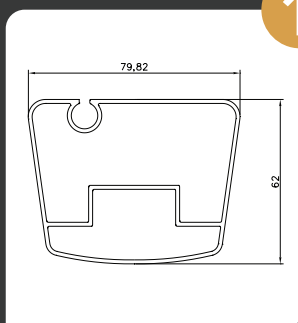

PROFIL VELIKE PERGOLE

DIMENZIJA: 79,82x62mm

Aluminijum LEGURE EN AW-6063, čvrstoće F22

2

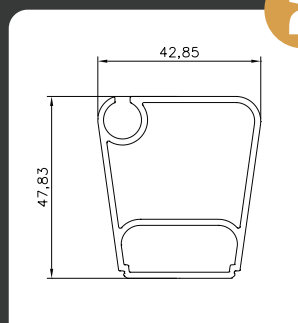

PROFIL MALE PERGOLE

DIMENZIJA: 42,85x47,83mm

Aluminijum LEGURE EN AW-6063, čvrstoće F22



FP-60

Pergola tenda

FP – 60

PERGOLA TENDA

Pergola tenda FRIENDLY PRICE – 60

Predstavlja dvovodni sistem pergola tende konstruisan od aluminijskih i čeličnih profila te troslojnog PVC platna. Glavna karakteristika ovog sistema je ta da ovaj sistem tende nema prednjih i zadnjih stubova već se stabilnost tende ostvaruje sa srednjim čeličnim stubovima i zategama. Srednji dio tende se oslanja na čelične stubove a prednji dio tende se preko zatega povezuje sa čeličnim stubom čime se dobija stabilna konstrukcija.

Otvaranje i zatvaranje krova tende se vrši na motorni pogon i upravlja daljinskim upravljačem.

BOJA PROFILA:

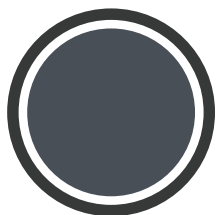

ANTRACIT

BOJA PLATNA:

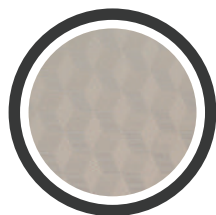

KREM 3D

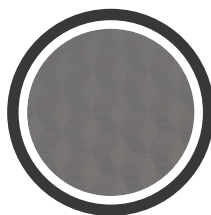

SIVA 3D



FP - 60

Model

Specifikacije

Maksimalna projekcija: 7m

Boja profila: Antracit (osnova)

Boja platna: 3D Siva ili krem

Somfy elektromotor

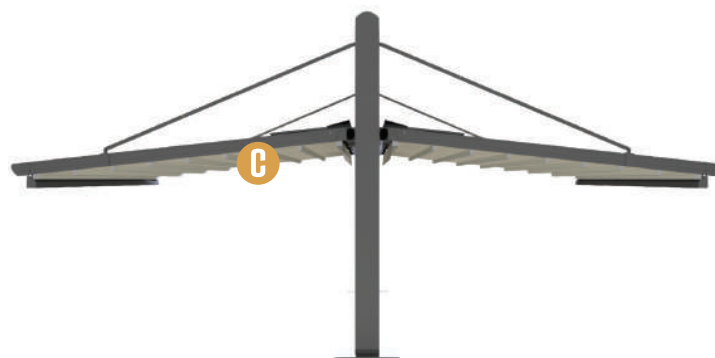
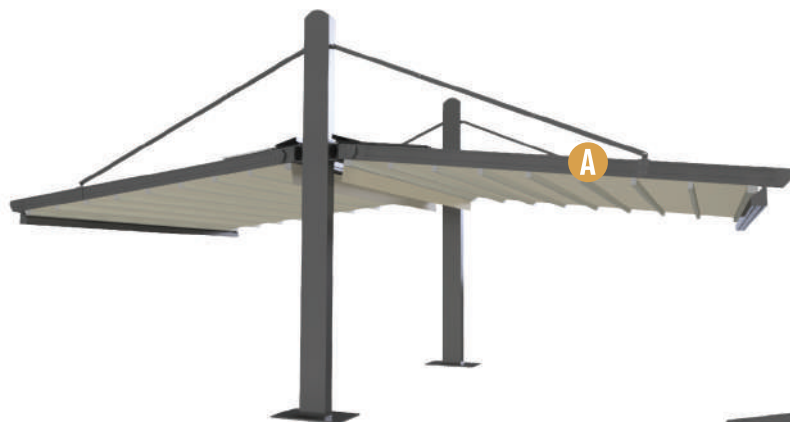

POPREČNI PRESJECI



A

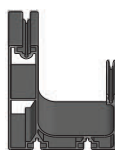

B



C

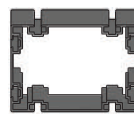

D

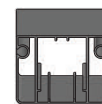

E

ALUMINIJSKI PROFILI

ZA NOVI SISTEM PERGOLA TENDE

A

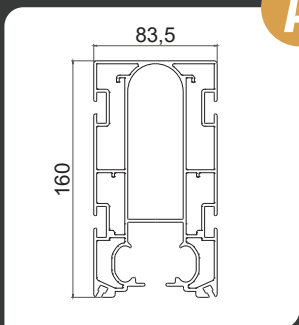

PROFIL VODILICE

DIMENZIJA: 160x83,5mm

Aluminijum LEGURE EN AW-6063, čvrstoće F22

B

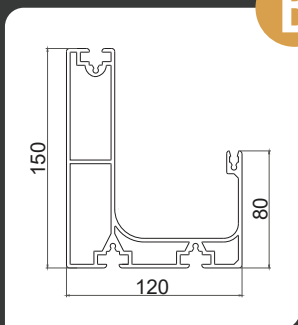

PROFIL OLUKA

DIMENZIJA: 150x120mm

Aluminijum LEGURE EN AW-6063, čvrstoće F22

C

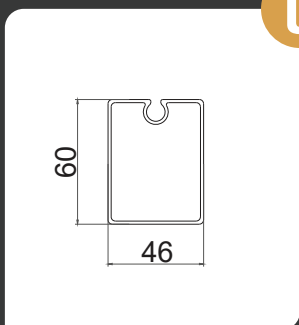

PROFIL MALE PERGOLE

DIMENZIJA: 60x46mm

Aluminijum LEGURE EN AW-6063, čvrstoće F22

D

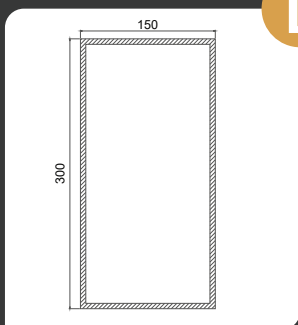

PROFIL ZIONJEG STUBA

DIMENZIJA: 300x150mm

Aluminijum LEGURE EN AW-6063, čvrstoće F22

E

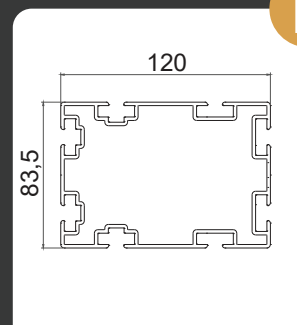

PROFIL STUBA-GREDA

DIMENZIJA: 120x83,5mm

Aluminijum LEGURE EN AW-6063, čvrstoće F22

F

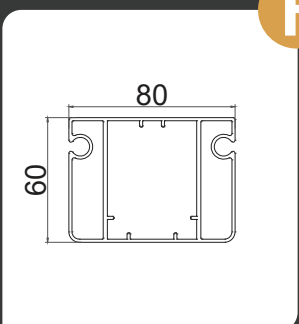

PROFIL VELIKE PERGOLE

DIMENZIJA: 80x60mm

Aluminijum LEGURE EN AW-6063, čvrstoće F22

1

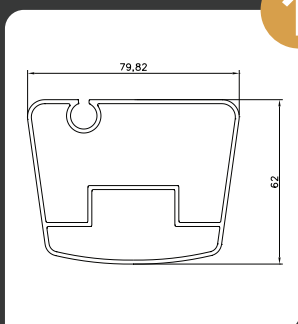

PROFIL VELIKE PERGOLE

DIMENZIJA: 79,82x62mm

Aluminijum LEGURE EN AW-6063, čvrstoće F22

2

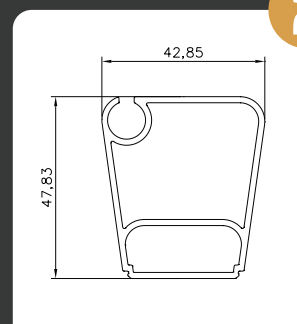

PROFIL MALE PERGOLE

DIMENZIJA: 42,85x47,83mm

Aluminijum LEGURE EN AW-6063, čvrstoće F22



PP-10

Pergola tenda

PP – 10

PERGOLA TENDA

Pergola tenda PREMIUM PRICE – 10

predstavlja jednovodan sistem pergola tende sačinjene od aluminijumske konstrukcije i troslojnog PVC platna koji se zadnjom stranom oslanja na zid a prednjom na stubove. Svi profili su od aluminijuma LEGURE EN AW-6063, čvrstoće F22. Pokretanje sve vrši motornim pogonom.

BOJA PROFILA:

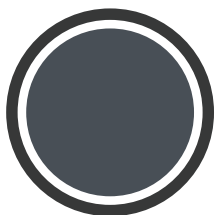

ANTRACIT

BOJA PLATNA:

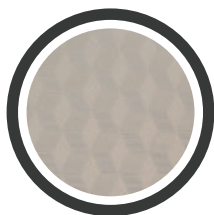

KREM 3D

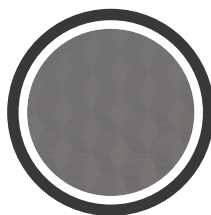

SIVA 3D



PP – 10

Model

Specifikacije

Maksimalna projekcija: 10m

Boja profila: Antracit (osnova)

Boja platna: 3D Siva ili krem

Somfy elektromotor

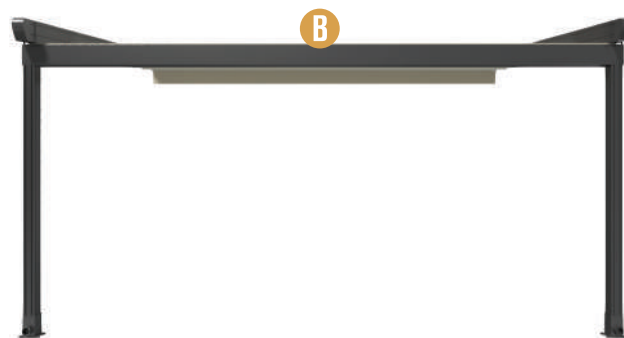

POPREČNI PRESJECI

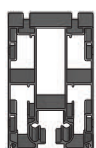

A

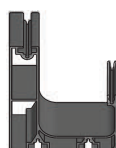

B



C



D



E

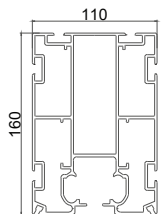

F

A**PROFIL VODILICE**

DIMENZIJA: 160x110mm

Aluminijum LEGURE EN AW-6063, čvrstoće F22

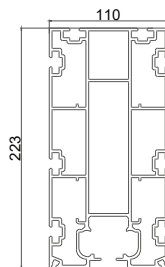
A**PROFIL VODILICE**

DIMENZIJA: 223x110mm

Aluminijum LEGURE EN AW-6063, čvrstoće F22

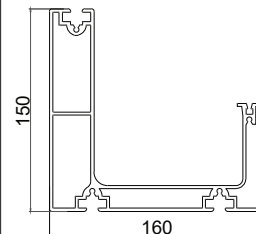
B**PROFIL OLUKA**

DIMENZIJA: 150x160mm

Aluminijum LEGURE EN AW-6063, čvrstoće F22

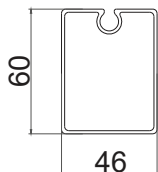
C**PROFIL MALE PERGOLE**

DIMENZIJA: 60x46mm

Aluminijum LEGURE EN AW-6063, čvrstoće F22

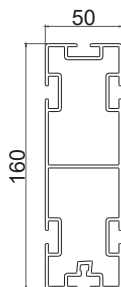
D**PROFIL ZIDNI - FASADNI**

DIMENZIJA: 160x50mm

Aluminijum LEGURE EN AW-6063, čvrstoće F22

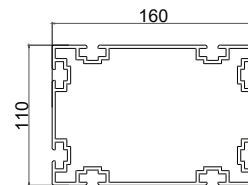
E**PROFIL STUBA - GREDA**

DIMENZIJA: 160x110mm

Aluminijum LEGURE EN AW-6063, čvrstoće F22

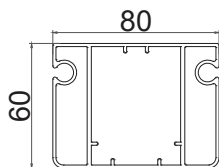
F**PROFIL VELIKE PERGOLE**

DIMENZIJA: 80x60mm

Aluminijum LEGURE EN AW-6063, čvrstoće F22

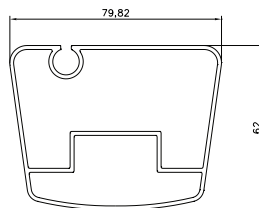
1**PROFIL VELIKE PERGOLE**

DIMENZIJA: 79,82x62mm

Aluminijum LEGURE EN AW-6063, čvrstoće F22

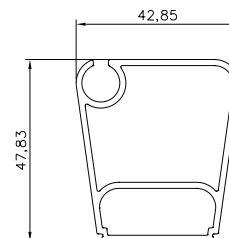
2**PROFIL MALE PERGOLE**

DIMENZIJA: 42,85x47,83mm

Aluminijum LEGURE EN AW-6063, čvrstoće F22



PP-20

Pergola tenda

PP – 20

PERGOLA TENDA

Pergola tenda PREMIUM PRICE – 20

predstavlja jednovodan sistem pergola tende sačinjene od aluminijumske konstrukcije i troslojnog PVC platna koji se zadnjom stranom i prednjom stranom oslonjen na stubove. Svi profili su od aluminijuma LEGURE EN AW-6063, čvrstoće F22. Pokretanje sve vrši motornim pogonom.

BOJA PROFILA:

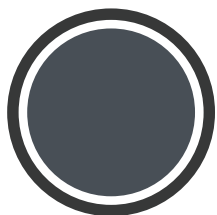

ANTRACIT

BOJA PLATNA:

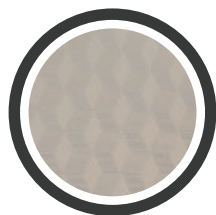

KREM 3D

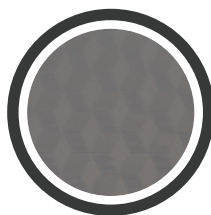

SIVA 3D



PP – 20

Model

Specifikacije

Maksimalna projekcija: 10m

Boja profila: Antracit (osnova)

Boja platna: 3D Siva ili krem

Somfy elektromotor

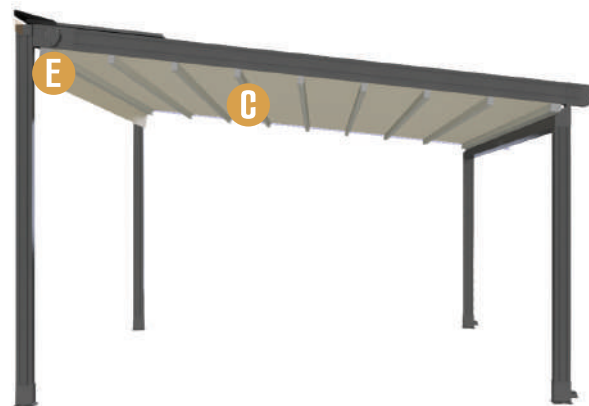
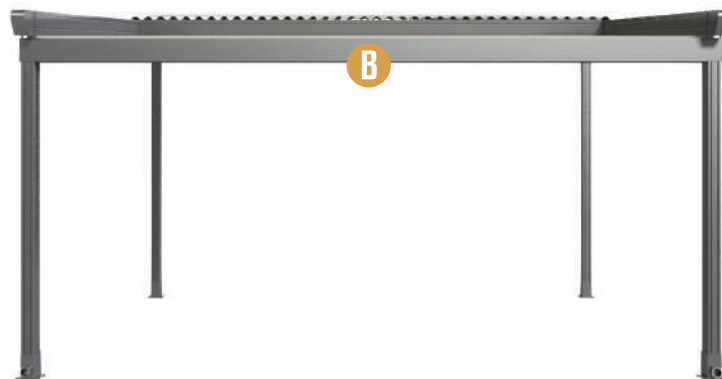

POPREČNI PRESJECI

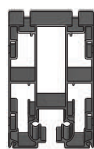

A

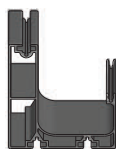

B



C

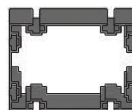

D

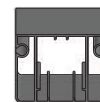

E

ALUMINIJSKI PROFILI

ZA NOVI SISTEM PERGOLA TENDE

A

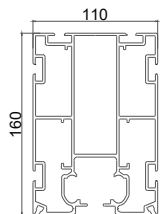

PROFIL VODILICE

DIMENZIJA: 160x110mm

Aluminijum LEGURE EN AW-6063, čvrstoće F22

A

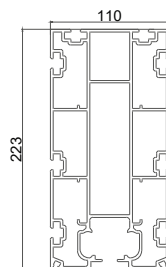

PROFIL VODILICE

DIMENZIJA: 223x110mm

Aluminijum LEGURE EN AW-6063, čvrstoće F22

B

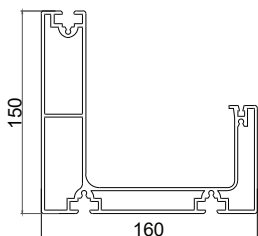

PROFIL OLUKA

DIMENZIJA: 150x160mm

Aluminijum LEGURE EN AW-6063, čvrstoće F22

C

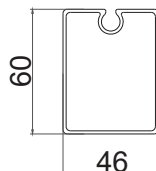

PROFIL MALE PERGOLE

DIMENZIJA: 60x46mm

Aluminijum LEGURE EN AW-6063, čvrstoće F22

D

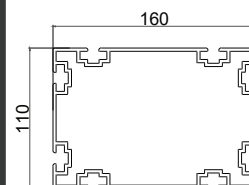

PROFIL STUBA-GREDA

DIMENZIJA: 160x110mm

Aluminijum LEGURE EN AW-6063, čvrstoće F22

E

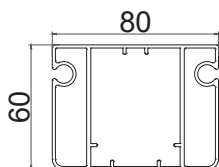

PROFIL VELIKE PERGOLE

DIMENZIJA: 80x60mm

Aluminijum LEGURE EN AW-6063, čvrstoće F22

1

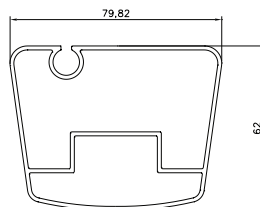

PROFIL VELIKE PERGOLE

DIMENZIJA: 79,82x62mm

Aluminijum LEGURE EN AW-6063, čvrstoće F22

2

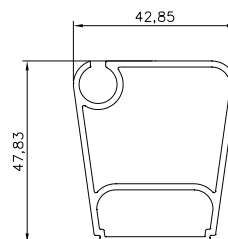

PROFIL MALE PERGOLE

DIMENZIJA: 42,85x47,83mm

Aluminijum LEGURE EN AW-6063, čvrstoće F22



PP-30

Pergola tenda

PP – 30

PERGOLA TENDA

Pergola tenda PREMIUM PRICE – 30

predstavlja jednovodan sistem pergola tende sačinjene od aluminijumske konstrukcije i troslojnog PVC platna koji se kača zategama na zid ili na čelični stub. Svi profili su od aluminijuma LEGURE EN AW-6063, čvrstoće F22. Pokretanje sve vrši motornim pogonom.

BOJA PROFILA:

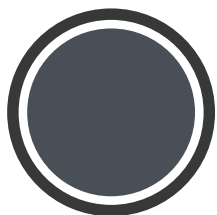

ANTRACIT

BOJA PLATNA:

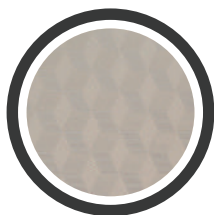

KREM 3D

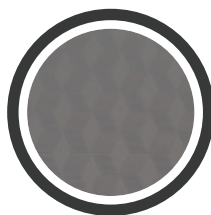

SIVA 3D



PP – 30

Model

Specifikacije

Maksimalna projekcija: 10m

Boja profila: Antracit (osnova)

Boja platna: 3D Siva ili krem

Somfy elektromotor

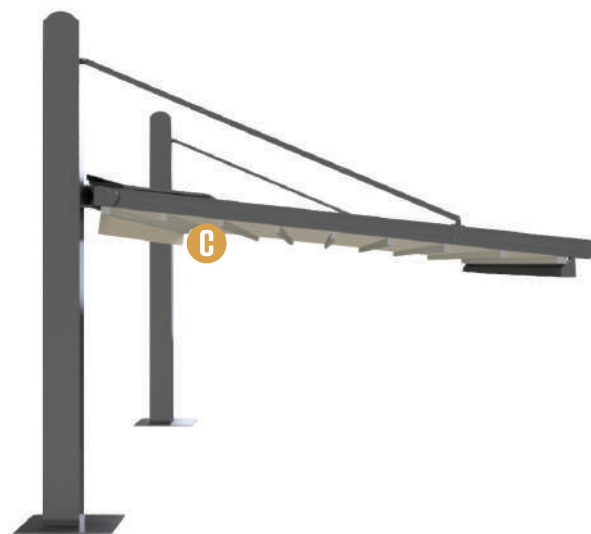
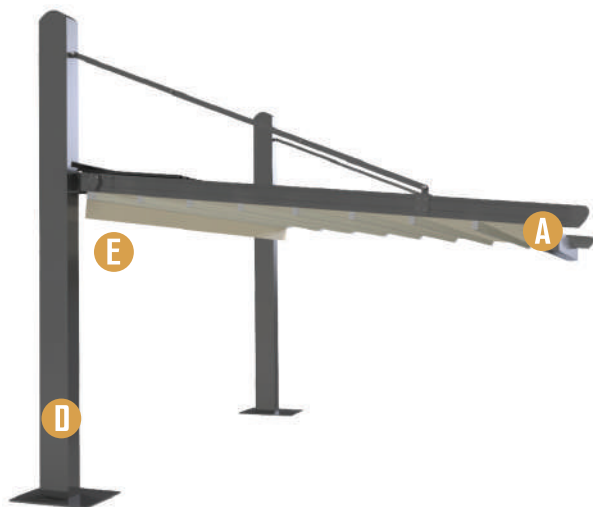
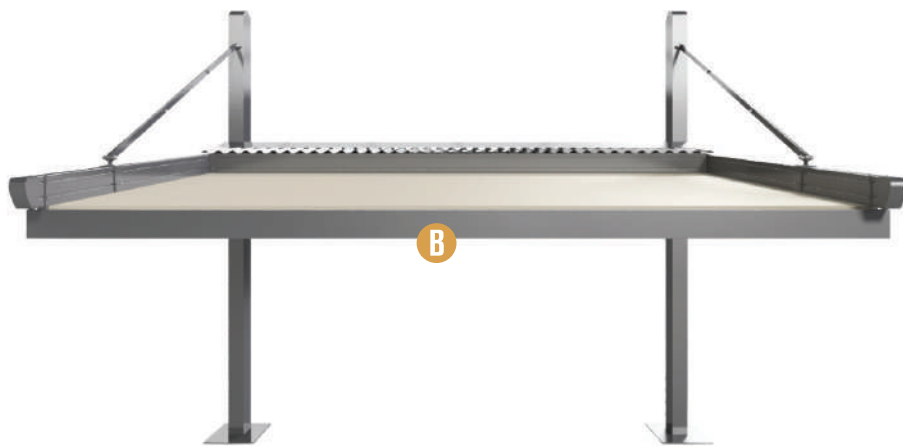

POPREČNI PRESJECI

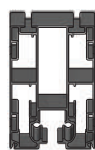

A

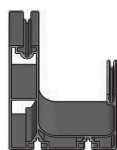

B



C

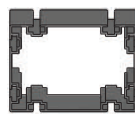

D

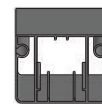

E

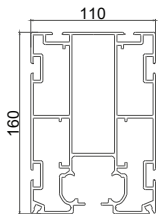
A**PROFIL VODILICE**

DIMENZIJA: 160x110mm

Aluminijum LEGURE EN AW-6063, čvrstoće F22

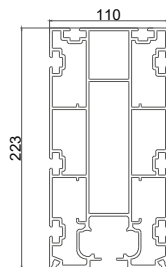
A**PROFIL VODILICE**

DIMENZIJA: 223x110mm

Aluminijum LEGURE EN AW-6063, čvrstoće F22

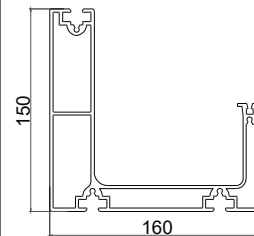
B**PROFIL OLUKA**

DIMENZIJA: 150x160mm

Aluminijum LEGURE EN AW-6063, čvrstoće F22

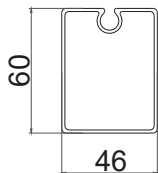
C**PROFIL MALE PERGOLE**

DIMENZIJA: 60x46mm

Aluminijum LEGURE EN AW-6063, čvrstoće F22

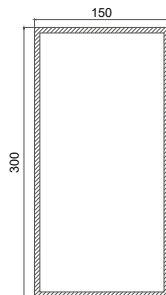
D**PROFIL ZIDNEG STUBA**

DIMENZIJA: 300x150mm

Aluminijum LEGURE EN AW-6063, čvrstoće F22

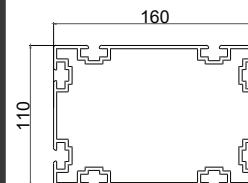
E**PROFIL STUBA-GREDA**

DIMENZIJA: 160x110mm

Aluminijum LEGURE EN AW-6063, čvrstoće F22

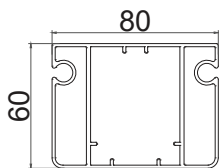
F**PROFIL VELIKE PERGOLE**

DIMENZIJA: 80x60mm

Aluminijum LEGURE EN AW-6063, čvrstoće F22

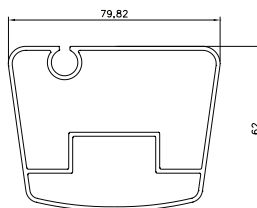
1**PROFIL VELIKE PERGOLE**

DIMENZIJA: 79,82x62mm

Aluminijum LEGURE EN AW-6063, čvrstoće F22

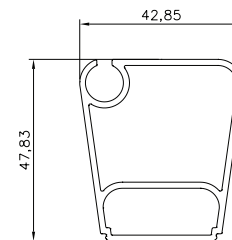
2**PROFIL MALE PERGOLE**

DIMENZIJA: 42,85x47,83mm

Aluminijum LEGURE EN AW-6063, čvrstoće F22



PP-40

Pergola tenda

PP – 40

PERGOLA TENDA

Pergola tenda PREMIUM PRICE – 40

predstavlja jednovodan sistem pergola tende sačinjene od aluminijumske konstrukcije i troslojnog PVC platna koji se kača zategama na čelični stub lučnog oblika. Svi profili su od aluminijuma LEGURE EN AW-6063, čvrstoće F22. Pokretanje sve vrši motornim pogonom.

BOJA PROFILA:

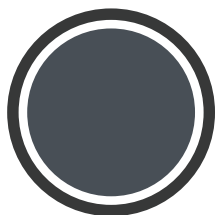

ANTRACIT

BOJA PLATNA:

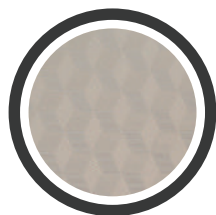

KREM 3D

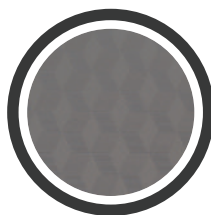

SIVA 3D



PP - 40

Model

Specifikacije

Maksimalna projekcija: 10m

Boja profila: Antracit (osnova)

Boja platna: 3D Siva ili krem

Somfy elektromotor

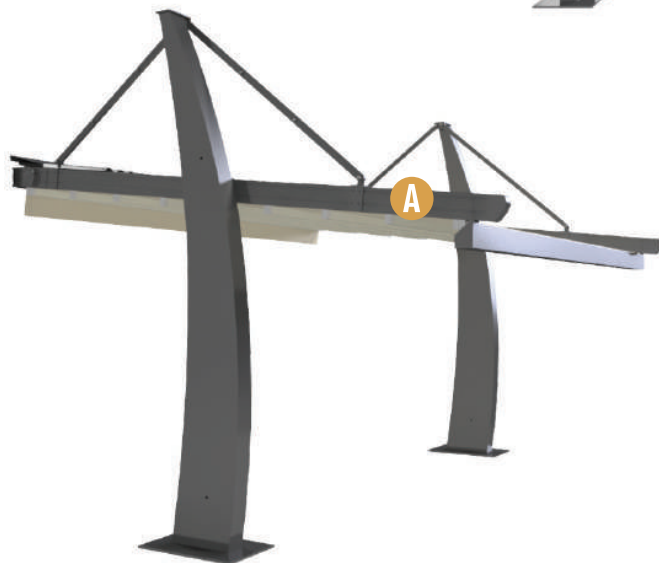
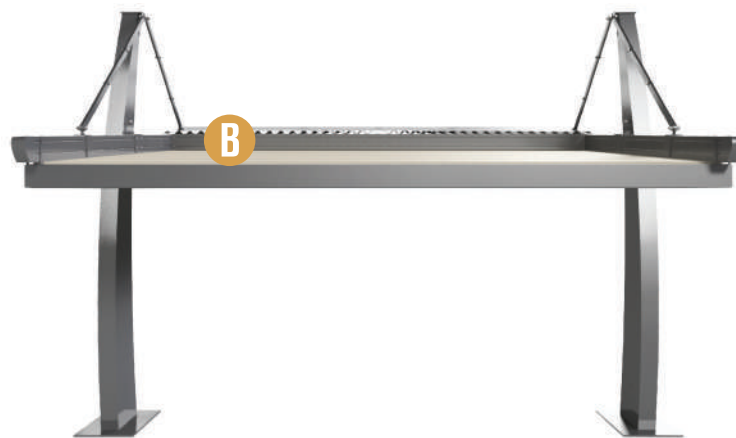

POPREČNI PRESJECI

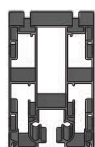

A

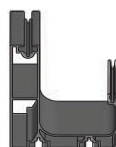

B



C



D

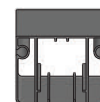

E

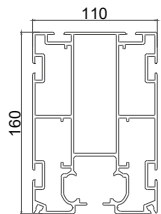
A**PROFIL VODILICE**

DIMENZIJA: 160x110mm

Aluminijum LEGURE EN AW-6063, čvrstoće F22

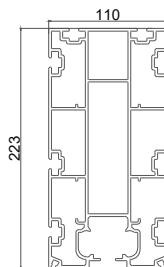
A**PROFIL VODILICE**

DIMENZIJA: 223x110mm

Aluminijum LEGURE EN AW-6063, čvrstoće F22

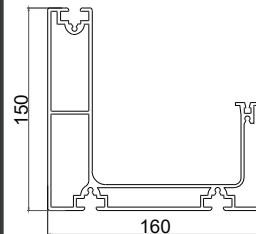
B**PROFIL OLUKA**

DIMENZIJA: 150x160mm

Aluminijum LEGURE EN AW-6063, čvrstoće F22

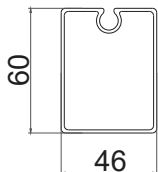
C**PROFIL MALE PERGOLE**

DIMENZIJA: 60x46mm

Aluminijum LEGURE EN AW-6063, čvrstoće F22

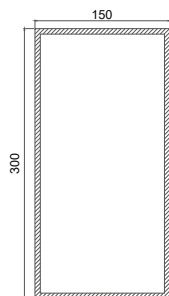
D**PROFIL ZIDNIJEG STUBA**

DIMENZIJA: 300x150mm

Aluminijum LEGURE EN AW-6063, čvrstoće F22

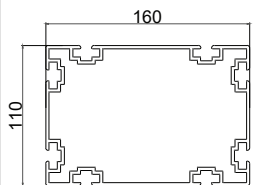
E**PROFIL STUBA-GREDA**

DIMENZIJA: 160x110mm

Aluminijum LEGURE EN AW-6063, čvrstoće F22

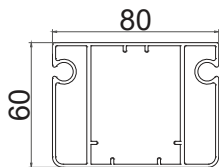
F**PROFIL VELIKE PERGOLE**

DIMENZIJA: 80x60mm

Aluminijum LEGURE EN AW-6063, čvrstoće F22

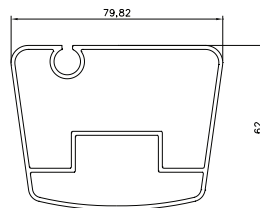
1**PROFIL VELIKE PERGOLE**

DIMENZIJA: 79,82x62mm

Aluminijum LEGURE EN AW-6063, čvrstoće F22

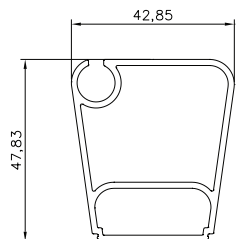
2**PROFIL MALE PERGOLE**

DIMENZIJA: 42,85x47,83mm

Aluminijum LEGURE EN AW-6063, čvrstoće F22



PP-50

Pergola tenda

PP – 50

PERGOLA TENDA

Pergola tenda PREMIUM PRICE – 50

predstavlja dvovodan sistem pergola tende sačinjene od aluminijumske konstrukcije i troslojnog PVC platna koji se zadnjom stranom i prednjom stranom oslonjen na stubove. Svi profili su od aluminijuma LEGURE EN AW-6063, čvrstoće F22. Pokretanje sve vrši motornim pogonom.

BOJA PROFILA:

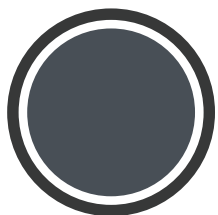

ANTRACIT

BOJA PLATNA:

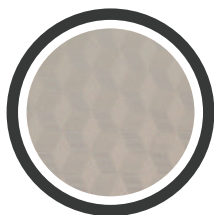

KREM 3D

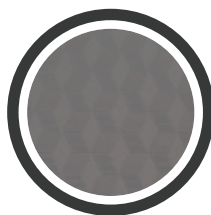

SIVA 3D



PP – 50

Model

Specifikacije

Maksimalna projekcija: 10m

Boja profila: Antracit (osnova)

Boja platna: 3D Siva ili krem

Somfy elektromotor

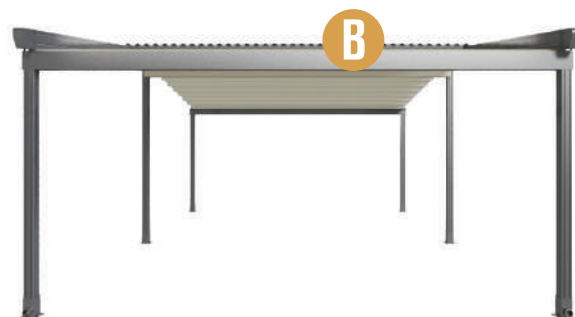

POPREČNI PRESJECI

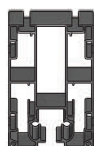

A

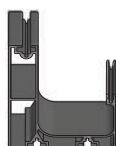

B



C

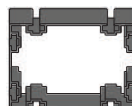

D

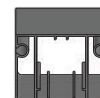

E

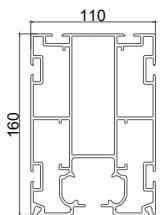
A**PROFIL VODILICE**

DIMENZIJA: 160x110mm

Aluminijum LEGURE EN AW-6063, čvrstoće F22

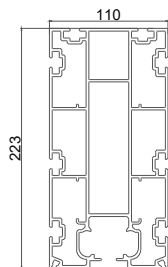
A**PROFIL VODILICE**

DIMENZIJA: 223x110mm

Aluminijum LEGURE EN AW-6063, čvrstoće F22

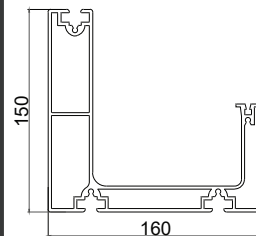
B**PROFIL OLUKA**

DIMENZIJA: 150x160mm

Aluminijum LEGURE EN AW-6063, čvrstoće F22

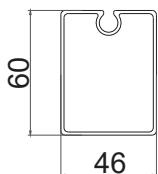
C**PROFIL MALE PERGOLE**

DIMENZIJA: 60x46mm

Aluminijum LEGURE EN AW-6063, čvrstoće F22

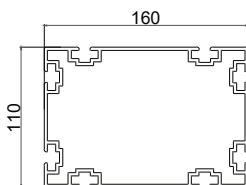
D**PROFIL STUBA-GREDA**

DIMENZIJA: 160x110mm

Aluminijum LEGURE EN AW-6063, čvrstoće F22

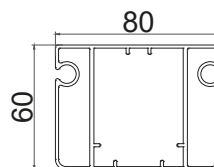
E**PROFIL VELIKE PERGOLE**

DIMENZIJA: 80x60mm

Aluminijum LEGURE EN AW-6063, čvrstoće F22

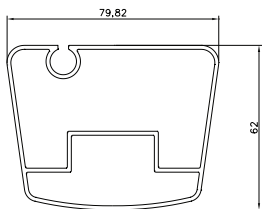
1**PROFIL VELIKE PERGOLE**

DIMENZIJA: 79,82x62mm

Aluminijum LEGURE EN AW-6063, čvrstoće F22

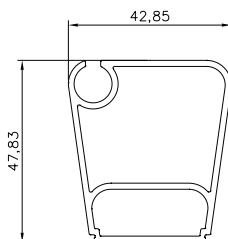
2**PROFIL MALE PERGOLE**

DIMENZIJA: 42,85x47,83mm

Aluminijum LEGURE EN AW-6063, čvrstoće F22



PP-60

Pergola tenda

PP – 60

PERGOLA TENDA

Pergola tenda PREMIUM PRICE – 60

predstavlja dvovodan sistem pergola tende sačinjene od aluminijumske konstrukcije i troslojnog PVC platna koji se kača zategama na čelični stub. Svi profili su od aluminijuma LEGURE EN AW-6063, čvrstoće F22. Pokretanje sve vrši motornim pogonom.

BOJA PROFILA:

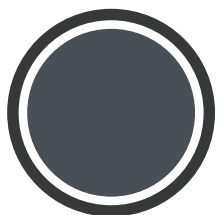

ANTRACIT

BOJA PLATNA:

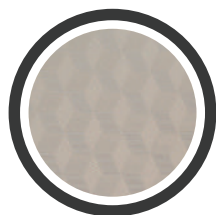

KREM 3D

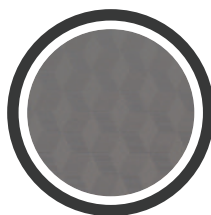

SIVA 3D



PP – 60

Model

Specifikacije

Maksimalna projekcija: 10m

Boja profila: Antracit (osnova)

Boja platna: 3D Siva ili krem

Somfy elektromotor

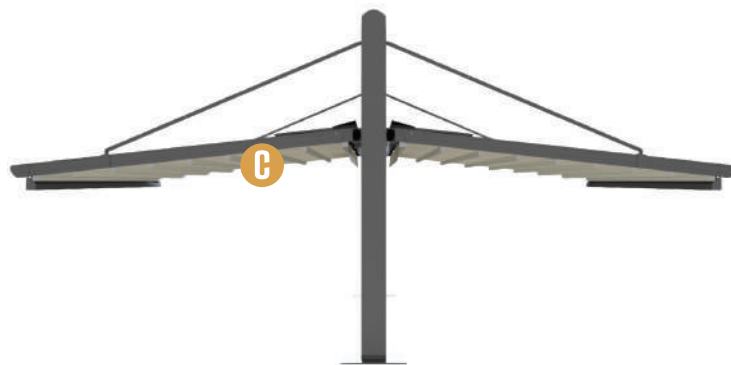
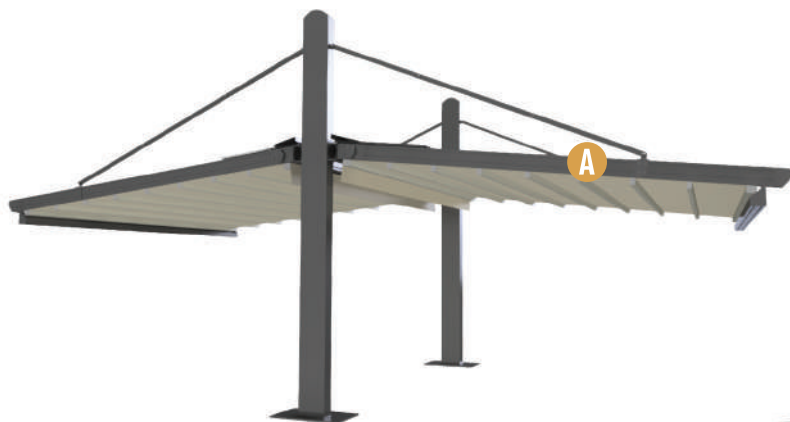

POPREČNI PRESJECI

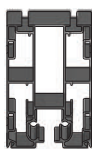

A

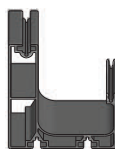

B



C

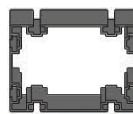

D

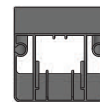

E

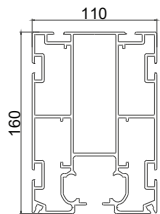
A**PROFIL VODILICE**

DIMENZIJA: 160x110mm

Aluminijum LEGURE EN AW-6063, čvrstoće F22

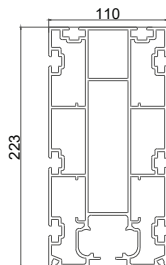
A**PROFIL VODILICE**

DIMENZIJA: 223x110mm

Aluminijum LEGURE EN AW-6063, čvrstoće F22

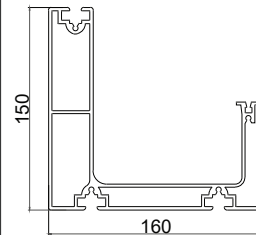
B**PROFIL OLUKA**

DIMENZIJA: 150x160mm

Aluminijum LEGURE EN AW-6063, čvrstoće F22

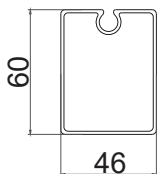
C**PROFIL MALE PERGOLE**

DIMENZIJA: 60x46mm

Aluminijum LEGURE EN AW-6063, čvrstoće F22

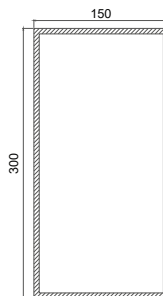
D**PROFIL ZIDNJEG STUBA**

DIMENZIJA: 300x150mm

Aluminijum LEGURE EN AW-6063, čvrstoće F22

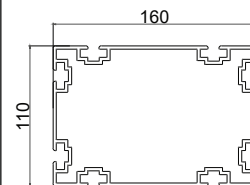
E**PROFIL STUBA-GREDA**

DIMENZIJA: 160x110mm

Aluminijum LEGURE EN AW-6063, čvrstoće F22

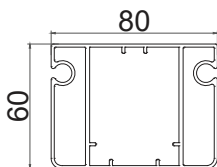
F**PROFIL VELIKE PERGOLE**

DIMENZIJA: 80x60mm

Aluminijum LEGURE EN AW-6063, čvrstoće F22

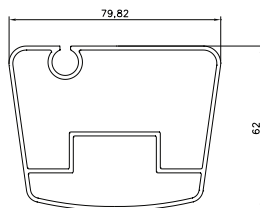
1**PROFIL VELIKE PERGOLE**

DIMENZIJA: 79,82x62mm

Aluminijum LEGURE EN AW-6063, čvrstoće F22

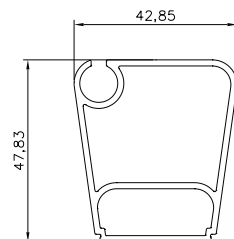
2**PROFIL MALE PERGOLE**

DIMENZIJA: 42,85x47,83mm

Aluminijum LEGURE EN AW-6063, čvrstoće F22

NOVI SISTEM

Pergola tenda



RATTAN
SEDIA

NOVI SISTEM

PERGOLA TENDA

Konstantnim praćenjem tržišta, naprednim inovacijama i usavršavanjem u natkrivanju bašti i terasa, postali smo **vodeća kompanija** za ovaj tip projekata u regionu. Prateći trendove društva i modernog načina življenja, **razvili smo zasebnu liniju pergola tendi**, zasnovanu na najnovijim tehnologijama.

Sistem je **idealna za natkrivanje privatnih objekata**, ali i hotela, restorana, kafića i svih drugih objekata koji imaju prostor na otvorenom.

Novi sistem je primarno namijenjen distributerima. Karakterišu ga:

- 1) niža cijena,
- 2) brža i jednostavnija montaža,
- 3) lakši profili - lakši transport, skladištenje i manevrisanje,
- 4) vizualno privlačan/dopadljiv sistem (skriveni šrafovi, nježne linije),
- 5) izrada po željenim dimenzijama,
- 6) maksimalna dimenzija 9x6.

Kao **proizvođači** imamo veliku prednost naspram konkurencije, te omogućavamo maksimalnu podršku distributerima. Dajemo savjete, izrađujemo idejna grafička rješenja i zajedno pronalazimo najbolja praktična rješenja za njihove projekte. Pored svega, u mogućnosti smo se **prilagoditi i krajnjim kupcima**, kako po dizajnu i dimenzijama, tako i po cjenovnom rangu.

BOJA PROFILA:



ANTRACIT

BOJA PLATNA:



KREM 3D



SIVA 3D

REFERENTNI PROJEKTI



NOVOG SISTEMA





KLIZNI I VERTIKALNI SISTEM ZASTAKLJENJA



Pergola tende imaju mogućnost zastaklivanja, kako bi se prostor mogao grijati i/ili rashladiti, te tako koristiti tokom cijele godine. Klizni ili vertikalni sistem zastakljenja namijenjen je za ugradnju između stubova pergole. Riječ je o sistemu koji je idealan za zatvaranje tendi, balkona i terasa ugostiteljskih i privatnih objekata. Ovaj sistem se također može koristiti i za odvajanje prostorija unutar objekata, formiranje (ne)pušačkih zona itd.

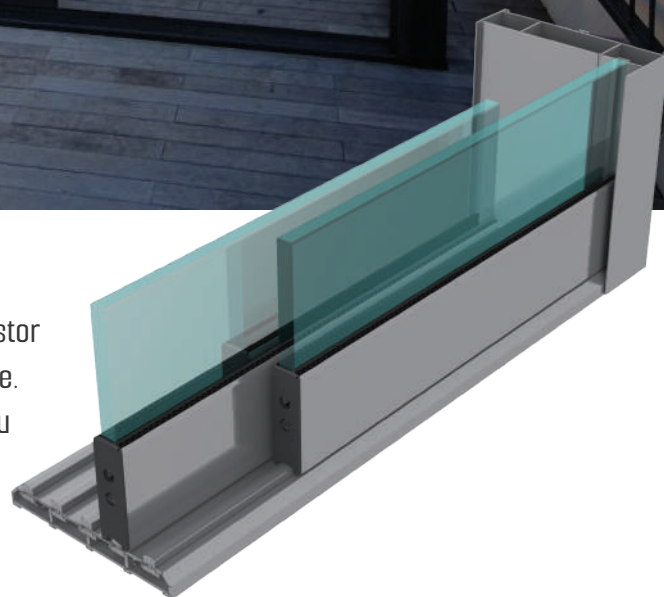



Kombinacija pergole i zastakljenja daje fleksibilnost bašti u smislu cjelogodišnjeg korištenja, omogućavajući stopostotnu propustljivost svjetlosti. Koristeći kaljeno staklo osiguravamo visok stepen sigurnosti, te otpornost na mehaničke i atmosferske utjecaje.

Troškovi održavanja su svedeni na minimum, a pokretanje i kontrola stakla u potpunosti pojednostavljeni.

Sistemi zastakljenja se izrađuju po željenoj preferenciji, uz mogućnost isporuke različitih dimenzija, boja i broja krila.

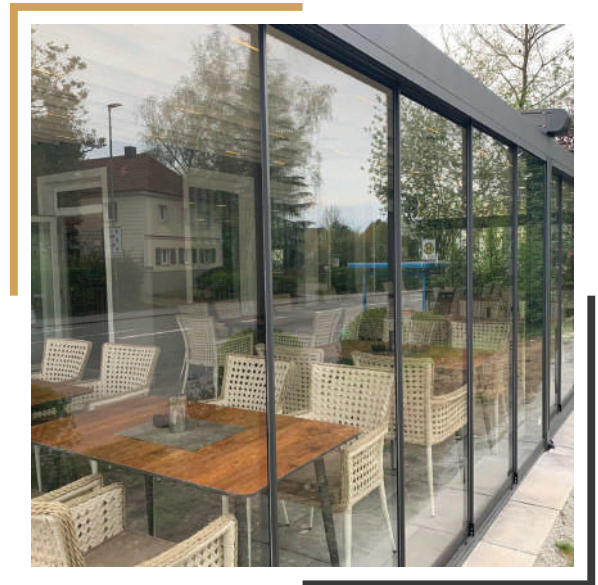
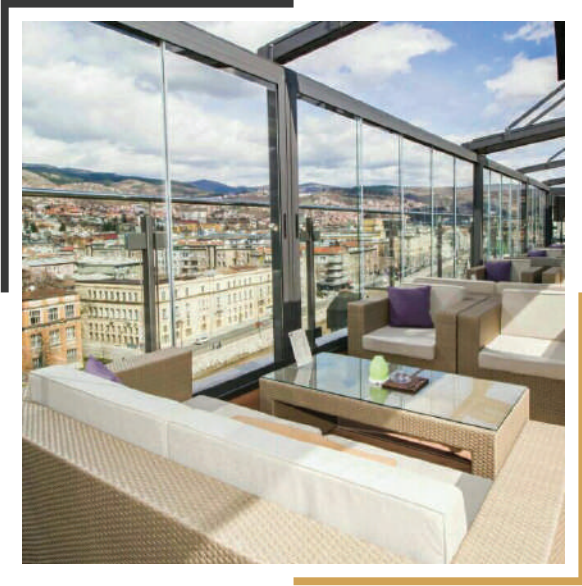



SCREEN – ZAŠTITA OD SUNCA



Screen zaštita od sunca je jedno od kvalitetnijih rješenja ukoliko je potrebno zatvoriti određenu površinu terase. Screen, naime, može eliminisati i do 90% toplotnog i UV zračenja. Screenovi su kao takvi ekonomično i jednostavno rješenje, ali također imaju inovativan dizajn koji poboljšava izgled terase. Smanjuje količinu svjetla i toplote, a istovremeno omogućava pogled iznutra. Štedi akumuliranu toplotu tokom zime, a povećava kvalitet vazduha tokom ljeta jer smanjuje potrebu za intenzivnom klimatizacijom.



Zahvaljujući svojoj funkcionalnosti, sistem screenova je prilagodljiv širokom spektru pozicija. Također, platno posjeduje stabilnost u dimenzijama i boji, a zadovoljava protupožarne uslove B1. Ovi sistemi se savršeno integrišu u bilo koju vrstu arhitekture i prilagođavaju se dizajnu pergole, fasade, stolarije i ostatka enterijera i eksterijera. Idealno je rješenje za privatne bašte, restorane, hotele, kafiće i druge ugostiteljske objekte. Moguća narudžba u različitim dimenzijama i bojama, uz različitu vrstu kontrole i upravljanja.



IZBOR BOJE PLATNA

Vanjska screen sjenila su otporna na vremenske uvjete i na zahtjevaju nikakvo održavanje. Odlikuje ih odlična funkcionalnost jer nude zaštitu od vrućine, a istovremeno propuštaju dovoljno prirodnog svjetla za ugodan boravak.

KUĆIŠTE MOTORA

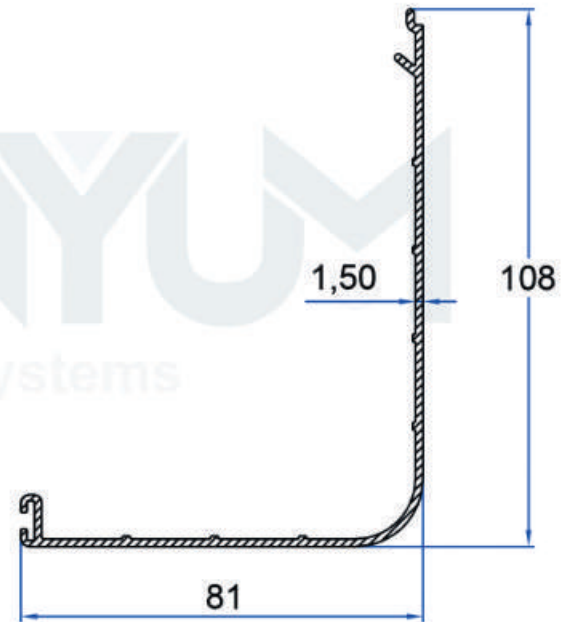
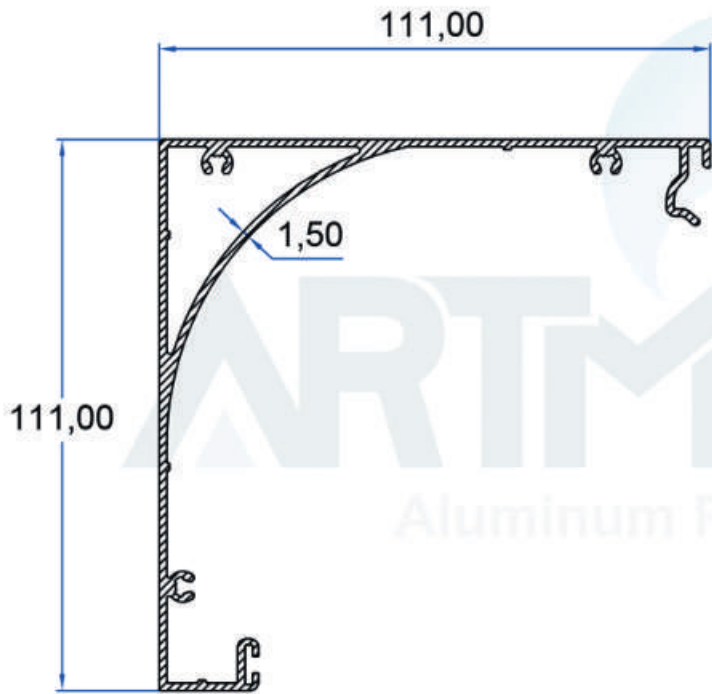

PROFILI ZIP SCREENA

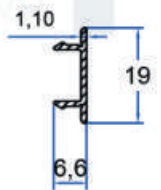
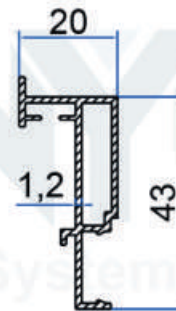
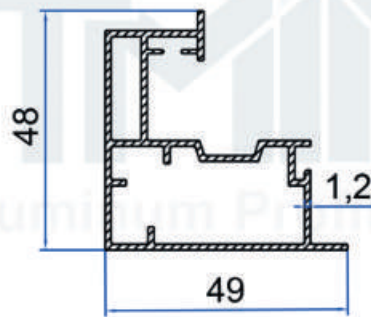
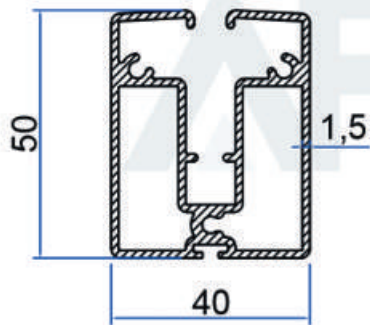





WPC DECKING

WPC (wood-plastic composite) je kombinacija drveta i plastike, te predstavlja idealno rješenje za podove koji su izloženi vanjskoj upotrebi. Najčešće se koristi kao podna obloga za vrtove, terase, bazene, dvorišta, plaže, molove, staze za parkove, planinske kućice. Može se koristiti i kao fasadna obloga, zatim za izradu žardinjera, klupa, stepeništa i slično. Uloga drveta kao sastavnog dijela kompozita je da mu osigura odgovarajuću čvrstinu i stabilnost, dok plastika predstavlja vezivni element. WPC profili su kao takvi stekli veliku popularnost kao siguran, ekološki održiv i dugotrajan materijal za upotrebu u otvorenom prostoru. Idealna su i finansijski pristupačna zamjena za drvene podne obloge, a dodatna prednost je i to što se za razliku od drveta mogu savijati i fiksirati u razne oblike.

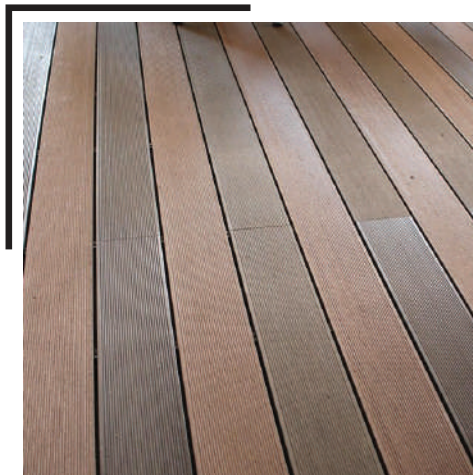
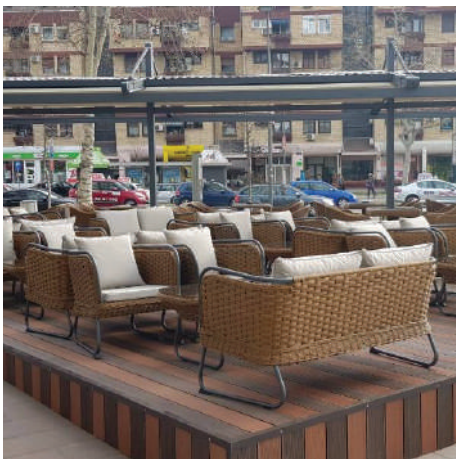



PKS - 03



PTS - 03



PWS - 03



PCS - 03



10 ključnih karakteristika WPC profila

- prirodan izgled; vizualni i taktilni dojam drveta
- dugotrajnost
- vodootpornost
- nisu klizavi
- ne pucaju
- ne raspadaju se
- otporni na visoke i niske temperature
- jednostavna montaža
- mogućnost montaže bočno
- minimalni troškova održavanja



Nova kolekcija WPC profila u proizvodnji kompanije Rattan Sedia sadrži ukupno četiri boje koje se ističu elegantnim dizajnom, jedinstvenim osjećajem drveta i raznovrsnim nijansama. Nevažno da li se radi o ugostiteljskom objektu, privatnoj terasi, bazenu, stepeništu, ili potpuno drugačijim mjestima, naša široka ponuda profila iz ove kolekcije omogućit će da sve to dizajnirate u potpunosti u skladu s vašim potrebama i željama. Kombinacijom boja WPC profila stvorit ćete dodatnu svježinu prostora koja se vizualno itekako osjeti. Praćenje trendova, savjestan odabir najboljih materijala, dugogodišnje iskustvo i proizvodnja uz pomoć najnovijih tehnologija omogućuju nam da ponudimo najkvalitetnije WPC profile na tržištu. Tome u prilog ide i veliki broj referenci eminentnih hotela i ugostiteljskih objekata na području regiona.

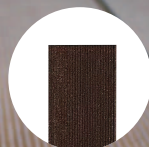

REFERENTNI PROJEKTI



HOTEL SVPETRVS, Brač

Tokom više od jedne decenije duge tradicije i proizvodnog iskustva u sektoru natkrivanja privatnih i ugostiteljskih objekata, Rattan Sedia je stvorila prepoznatljiv imidž kako na regionalnom tržištu, tako i na tržištu Evrope. Dominirajući na tržištu regije, bilježimo porast djelovanja i na području Evrope, odgovarajući najkompleksnijim projektima u velikim evropskim gradovima. Djelujući direktno, ili kroz mrežu naših distributera i partnera, godišnje projektujemo, konstruišemo, izrađujemo i opremamo stotine raznovrsnih objekata sa višestrukom mogućnosti korištenja. Od klasičnih pergola tendi u različitim varijacijama i modelima, preko tzv. zimskih bašti, pa sve do objekata po sistemu „ključ u ruke“ za cjelogodišnje korištenje – Rattan Sedia može ponuditi rješenje za svaki prostor. Nevažno da li se radi o privatnom ili ugostiteljskom prostoru, naš stručni tim će zahvaljujući višegodišnjem iskustvu moći ponuditi nekoliko opcija, a po potrebi izraditi i dizajnersko rješenje za vaš prostor sa nekoliko alternativa, te će takva 3D vizualizacija zasigurno eliminisati sve promašaje prije nego se upustite u investiciju. Činjenica je da je natkrivanje ugostiteljskih terasa, privatnih domova i drugih sličnih objekata neizbježna budućnost. Dovoljno je obratiti pažnju na trendove u svijetu, gdje većina privatnih domova u prigradskim i perifernim područjima posjeduje određeni vid ljetno-zimskog vrta. Pergola tenda doista predstavlja idealan model proširenja prostora, a kako smo mi to učinili širom Evrope pogledajte u nastavku. Prilagođavali smo se zahtjevima kupaca, kako po dizajnu i dimenzijama, tako i po njihovim ličnim preferencijama. Upoznat ćete se sa specifičnim projektima u kojima su pergola tende kombinovane sa kliznim ili vertikalnim sistemom zastakljenja, skrinovima, sjenilima, atikama, alubondom i drugim materijalima.





HELL'S BURGER, Varberg



HOTEL NEPTUN, Tučepi



RESTORAN 12 APOSTOLA, Hilden



RESTORAN BOSTON VISTAFON, Sarajevo



RESTORAN TRATTORIA BERTO, Velpke



RESTORAN VIS A VIS, Passau



RESTORAN BORAS, Borås

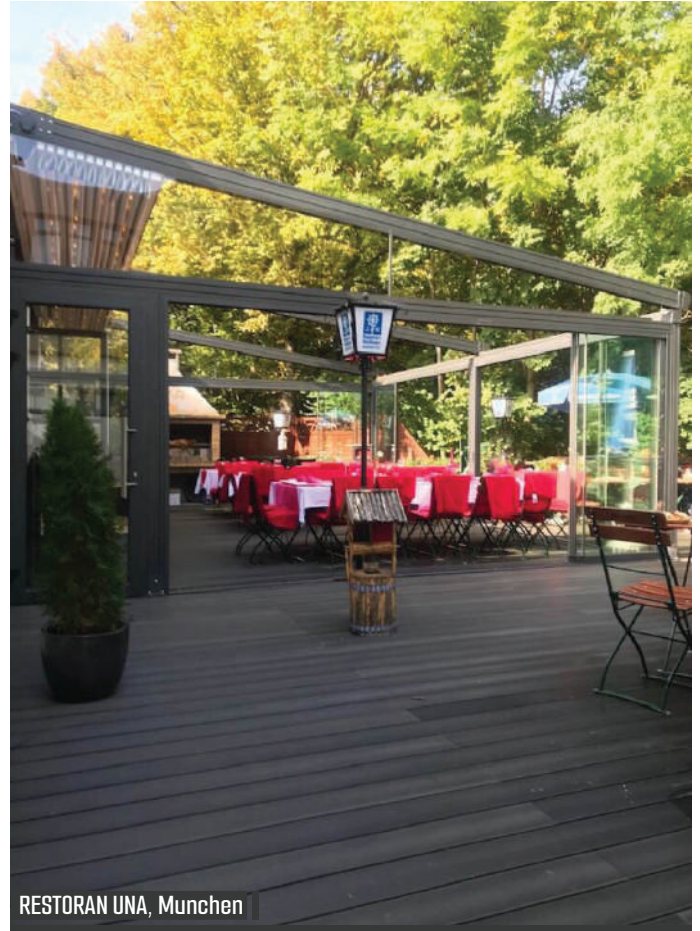

RESTORAN UNA, München



HOTEL HAUS REUSCHENBERG, Leverkusen



RESTORAN GALAXIE, Beč



RESTORAN GASTHAUS NEUWIRT, Salzburg



HOTEL MALAK, Sarajevo



CAFFE BAR KICKS, Heidenheim



CAFFE LA PARISIENNE, Podgorica



CAFFE MOCCA, Lukavica



HOTEL FONTANA, Budva

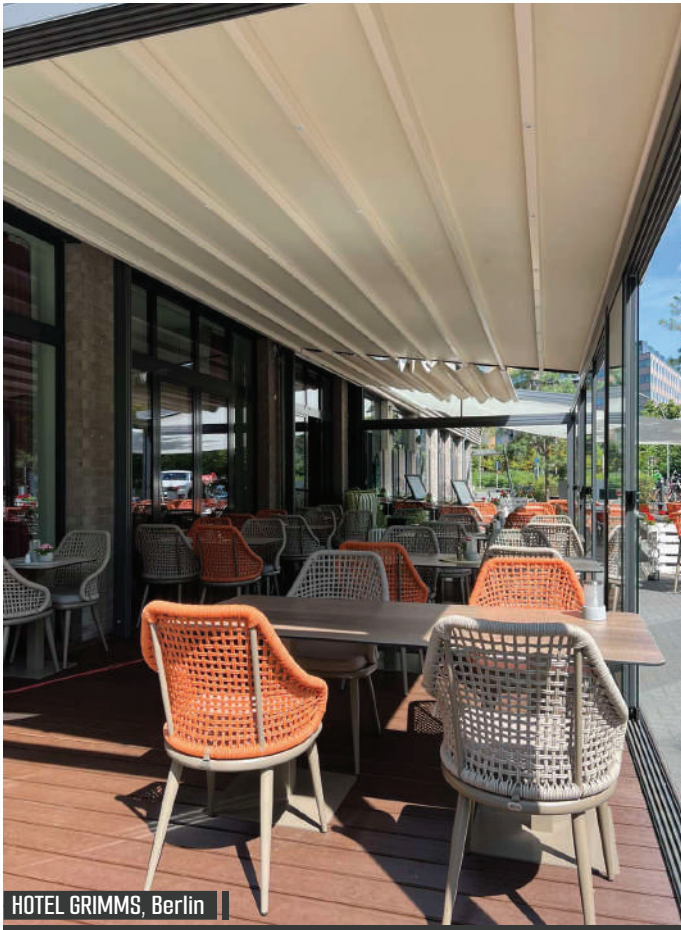

HOTEL GRIMMS, Berlin



CAFFÈ PETAR, Niš



CAFFÈ LEGGERO, Zagreb



HIPPI KLUPA, Sarajevo



CAFFÈ BAR BILBAO, Županja



CAFFÈ COOLTURA, Zenica



PIZZERIA MAMMA MIA, Primošten



HOTEL VERSO, Mostar



CAFFÈ MALA STANICA, Bijeljina



HOTEL NAVIS, Orašje



HOTEL VENEZIA, Imotski



RESTORAN CONCEPT PAUSE, Novi Sad



RESTORAN KAZALIŠNA KAVANA, Belišće



PRIVATNO, Krk



PRIVATNO, Salzburg



PRIVATNO, Nurnberg



PRIVATNO, Zurich



RATTAN SEDIA d.o.o. BIH

Cerik bb, Brčko distrikt, Bosna i Hercegovina
Tel.: + 387 49 590 911 | Mob.: + 387 62 543 099
+387 62 751 000 | +387 62 752 000 | +387 62 753 000
+387 62 333 603 | +387 63 830 840 | +387 62 745 745
Fax: +387 49 590 914
Marketing: +387 62 991 315
info@rattansedia.com | rattansedia@gmail.com

RATTAN SEDIA d.o.o. HR

Zagreb, Velimira Škorpika 11, Family Mall, Republika Hrvatska
Tel./Fax. +385 (0)1 29 46 064
Mob.: +385 91 60 555 34 | +385 91 60 555 35
+385 91 60 555 32 | +385 91 60 555 33
+385 91 60 555 36 | +385 91 60 555 37
+385 91 60 555 39
rattansedia.hr@gmail.com

RATTAN SEDIA d.o.o. SRB

Zrenjaninski put 110, Beograd, Srbija
Tel. +381 62 600 771 | + 381 62 600 770
+381 69 207 81 92
rattansedia.serbia@gmail.com

RATTAN SEDIA d.o.o. MNE

Radanovići bb, Kotor, Crna Gora
Tel. +382 32 302 308 | Mob: +382 69 871 820
+382 69 815 225 | +382 69 314 196
rattansedia.montenegro@gmail.com

www.rattansedia.com
www.opletti.com